

SPD

Surge Protective Device

SD25TxxxL100PV Series

Description



Surge Protection Device (SPD) for PV System is a device that provides surge protection for PV system. It plays a big role for preventing transient surge caused by direct or induced lightning strikes or other instantaneous overvoltage surges. It is suitable for photovoltaic power generation, wind power generation and other DC systems. When there is a sudden power spike in an electrical circuit or communication line due to external interference, the current or voltage is high, the Surge Protective Device (SPD) can conduct and discharge in a very short time to prevent the power surge damaging other parts of the circuit.

SETsafe | SETfuse's Surge Protective Device SD25TxxxL100PV series are mainly composed of varistor (MOV), pluggable module, base and internal and external electrode. Nominal discharge current: 25kA, Maximum continuous operating voltage: (180 ~ 895)VDC, certification: UL, cUL, TUV, CE, complied with RoHS and REACH.

Dimensions (mm)

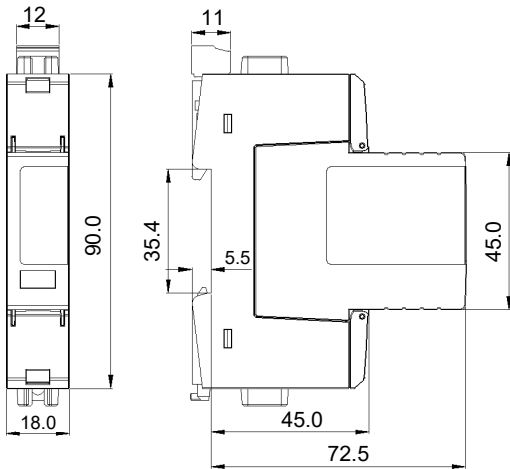

Schematics

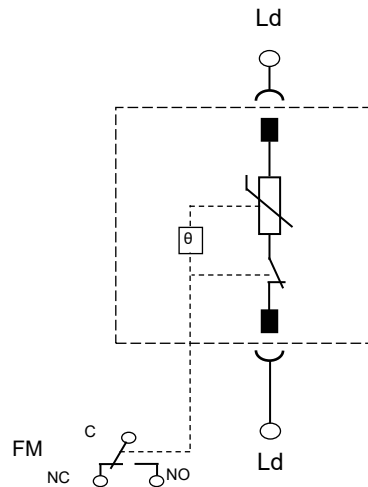

Features

- With Remote Signal Contact and Failure Indication
- Pluggable Module for Easy Replacement
- Internal Thermal Protection, Fail-safe
- For Photovoltaic DC and DC system

Applications

- Photovoltaic Inverter
- Distribution Power Unit (DPU)
- DC Lightning Protection Box
- DC Power Supply
- Energy Storage Converter
- DC Junction Box

Wiring Diagram

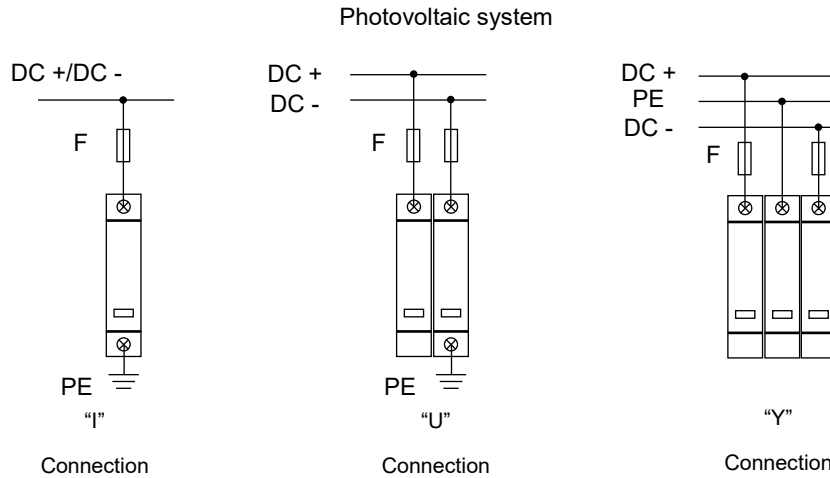

Specifications

Features	Specifications
Degrees of Protection Provided	IP20
Wiring Ability	(1.5 ~ 25) mm ² (Flexible) / 35 mm ² (Rigid)
Installation	35 mm DIN rail
Alarm	Remote + Indicator
Operating State / Fault Indication	Green (OK) / Red (Fault)
Remote Indication Contacts	AC: 250 V / 0.5 A , 125 V / 1.0 A DC: 250 V / 0.1 A , 125 V / 0.2 A , 75 V / 0.5 A
Cross-section of Remote Indication Conductors	1.5 mm ²
Maximum Overcurrent Protection on the Power Supply Side	200 A gPV
Short Current Rating I_{SCPV}	1000 A
According to Standard	UL 1449, IEC/ EN 61643-31
Altitude	-500 ~ 5000 m
Operational Temperature Range	(-40 ~ 85) °C

Specifications

Model	Max. Continuous Operating Voltage	Impulse Discharge Current (10/350 μs)	Nominal Discharge Current (8/20 μs)	Max. Discharge Current (8/20 μs)	Voltage Protection Level	Modes of Protection	Agency	Agency
	(U_c)	(I_{imp})	(I_n)	(I_{max})	(U_p)		TUV	UL
SD25T100L100PV	180 VDC	12.5 kA	25 kA	50 kA	1.0 kV	+/- — PE	○	●
SD25T200L100PV	250 VDC	12.5 kA	25 kA	50 kA	1.3 kV		○	●
SD25T300L100PV	330 VDC	12.5 kA	25 kA	50 kA	1.5 kV		○	●
SD25T400L100PV	450 VDC	11 kA	25 kA	50 kA	2.0 kV		○	●
SD25T500L100PV	550 VDC	10 kA	25 kA	50 kA	2.1 kV		●	●
SD25T600L100PV	670 VDC	7.5 kA	25 kA	50 kA	2.5 kV		●	●
SD25T800L100PV	895 VDC	5.0 kA	25 kA	50 kA	3.2 kV		●	●



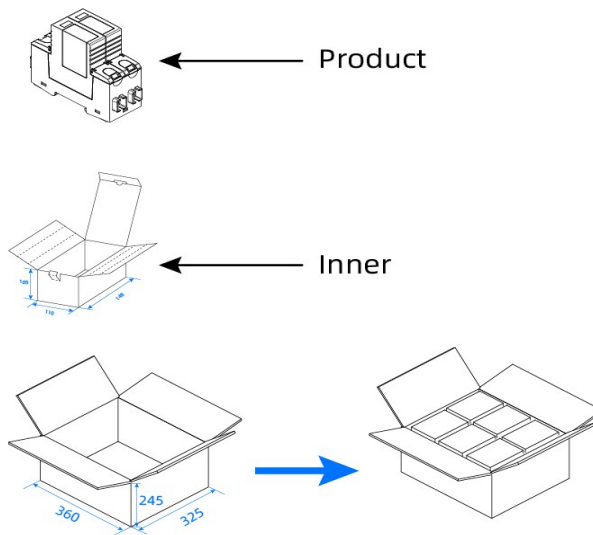

"●" indicates that the product has been certified, and "○" indicates that the product has not been certified.

Packaging Information



Item	Inner	carton
Package Size (mm)	98x 80 x 76	420 × 315 × 175
Quantity (PCS)	4	48

Agency Information

Agency Information		Standards	NO.	Category
	UL	UL 1449	E322662	Type 4CA
	CUL	CSA C22.2 NO.269.5	E322662	Type 4CA
	TUV	IEC/EN 61643-31	R 50535519	Class II and Class I
	CE	IEC/EN 61643-31	AN 5053554	Class II and Class I

Part Numbering System

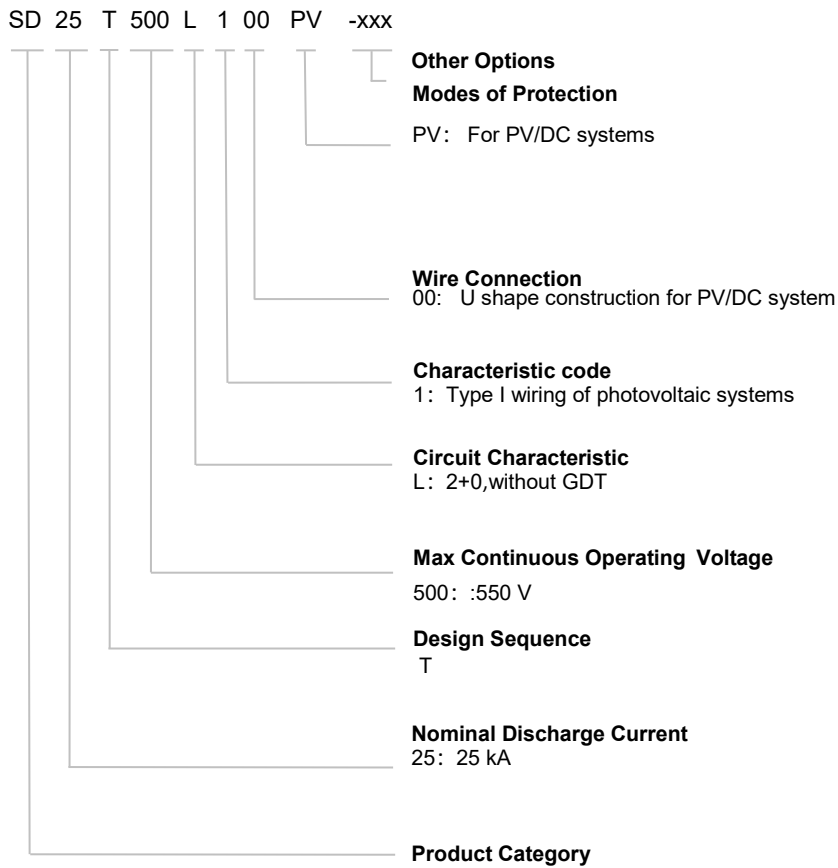

Reminder:

Part numbering system in the datasheet is only for selecting correct parameter and product features. Before placing order, please contact us for specifications and use the part number and product code in the specifications to place order to ensure the part is correct. Product code is the unique identification.

Overvoltage

Electricity is an essential part of modern human production and life. But power facilities are threatened by internal and external overvoltages. Power system overvoltage mainly includes:

Transient overvoltage of atmospheric origin: Lightning strikes instantly generate high energy, generating surge currents up to hundreds of kA, and lightning wave can invade along power lines, causing damage to power facilities and electrical equipment

Transient overvoltage due to switching: Switching operations of a power utility may cause overvoltage.

Temporary overvoltage: A long duration (second level) temporary overvoltage (asymmetric ground fault) or harmonious overvoltage.

Surge Voltage Caused by Lightning

Electrical and electronic system are subject to damage from a lightning electromagnetic impulse (LEMP). Therefore SPM need to be provided avoid failure of internal system. LEMP may caused by direct, near and far lightning strikes. According to the relevant research, lightning strikes within a certain distance may cause dangerous overvoltage on the cable, endangering the equipment connected to it.

Damage Due to Lighting

The lighting can cause three basic type of damage:

- D1: injury to living beings by electric shock;
- D2: physical damage (fire, explosion, mechanical destruction, chemical release) due to lighting current effects, including sparking;
- D3: failure of internal systems due to LEMP

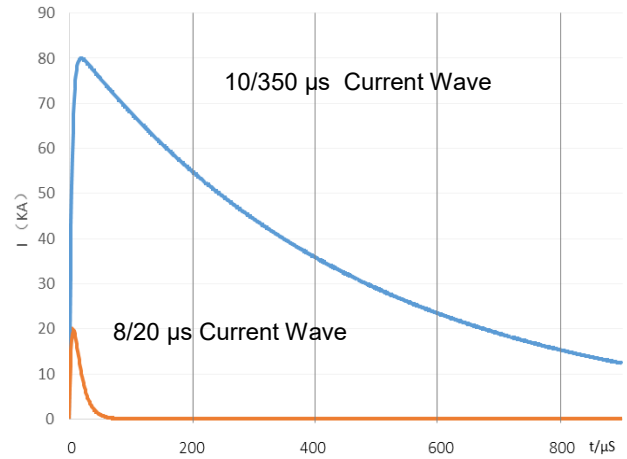

Standard lightning test wave

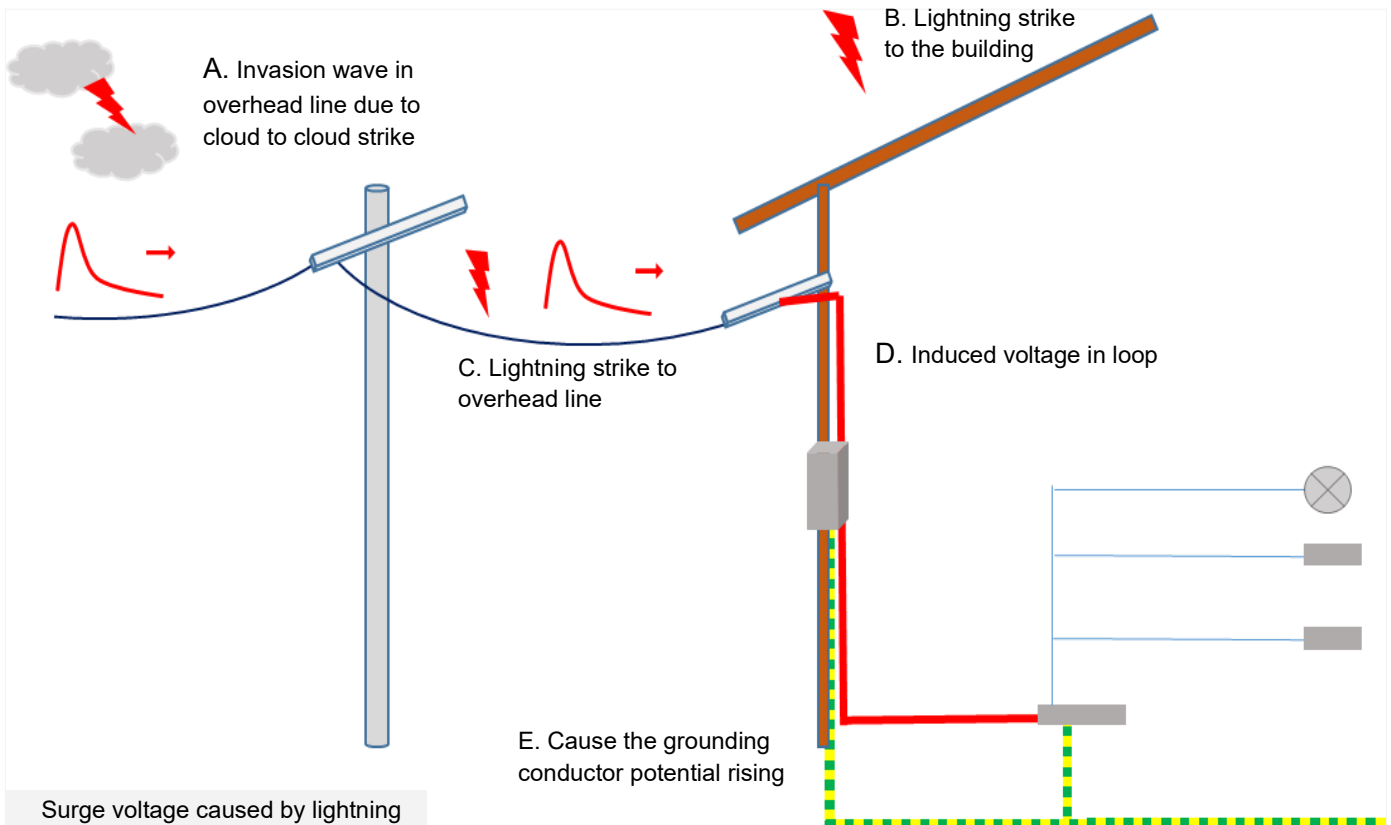

Surge voltage caused by lightning

Glossary

Item	Description
U_p	<p>Voltage Protection Level Maximum voltage to be expected at the SPD terminals due to an impulse stress with defined voltage steepness and an impulse stress with a discharge current with given amplitude and wave shape. — (IEC/EN 61643-11)</p>
8/20 μ s	<p>8/20 Current Impulse Current impulse with a nominal virtual front time of 8 μs and a nominal time to half-value of 20 μs. — (IEC/EN 61643-11)</p>
1.2/50 μ s	<p>1.2/50 Voltage Impulse Voltage impulse with a nominal virtual front time of 1.2 μs and a nominal time to half-value of 50 μs. — (IEC/EN 61643-11)</p>
U_c	<p>Maximum Continuous Operating Voltage Maximum r.m.s. voltage, which may be continuously applied to the SPD's mode of protection. — (IEC/EN 61643-11)</p>
I_n	<p>Nominal Discharge Current Crest value of the current through the SPD having a current waveshape of 8/20 μs. — (IEC/EN 61643-11)</p>
I_{imp}	<p>Impulse Discharge Current for Class I Test Crest value of a discharge current through the SPD with specified charge transfer Q and specified energy W/R in the specified time. — (IEC/EN 61643-11)</p>
I_{max}	<p>Maximum Discharge Current Crest value of a current through the SPD having an 8/20 μs waveshape and magnitude according to the manufacturer's specification. I_{max} is equal to or greater than I_n. — (IEC/EN 61643-11)</p>
Modes of Protection	<p>Modes of Protection An intended current path, between terminals that contains protective components, e.g. line-to-line, line-to-earth, line-to-neutral, neutral-to-earth. — (IEC/EN 61643-11)</p>
IP	<p>Degrees of Protection of enclosure Classification preceded by the symbol IP indicating the extent of protection provided by an enclosure against access to hazardous parts, against ingress of solid foreign objects and possibly harmful ingress of water. — (IEC 60529)</p>



ATTENTION

Usage

1. The voltage applied continuously to the SPD must not exceed its maximum continuous operating voltage U_c .
2. When atmosphere press is from 54 kPa to 106 kPa, the related altitude shall be from 5000 m to - 500 m.
3. Do not touch the product body or wires directly when power is on, to avoid electric shock.

Replacement

As SPD is a non-repairable product, for safety sake, please use the same type of SPD for replacement.

Storage

Do not store SPD at high temperature, high humidity or corrosive gas environment. Use them up within 2 years after receiving the goods.

Installation

1. Installation and startup may only be carried out by qualified personnel. The relevant country-specific regulations must be observed.
2. Check the device for external damage before installation. If the device is defective, it must not be used.
3. Pay attention to risk of electric shock. Please cutoff all electrical power before installation or service.
4. Lay the output cables to the surge protective devices (SPDs) as short as possible, without loops.
5. Please install proper backup protection devices in front of SPD.
6. Do not apply mechanical stress to the SPD body during or after the installation.

Maintenance

1. Check SPD status according to instructions before and after the thunderstorm season each year.
2. If the indicator of "failure state" appears, the SPD is damaged. Replace the SPD with same type.
3. Ensure electrical connections and mountings are correct before energizing the circuit.
4. SPD's quality is well controlled and strictly inspected before delivery. If non-functional ones are found during operation, please contact us early enough.